

ekinex

CONTROL YOUR LIVING SPACE

delégo server:

supervisory web-server for KNX standard building systems

Codes: EK-DEL-SRV-BAS-TP / EK-DEL-SRV-ADV-TP / EK-DEL-SRV-PRM-TP



Datasheet STEKDELSRVXXTP_EN



delégo server is a compact device to realize supervision and control systems for KNX standard systems, for mobile devices (iOS and Android smartphones and tablets), fixed (PC and MAC) and in combination with the delégo-panel series wall touch-screen panels. Through the integrated web-server, directly exposed to the Internet and connected to ekinex cloud services, delégo server is a versatile solution, suitable for the control of light, climate, blinds and shutters and energy of a modern KNX standard building and can be integrated with multimedia systems, video surveillance, video intercom and intrusion detection. The integrated voice-bridging service also allows control via voice commands given to Amazon and Google assistants.

Description

delégo server is a dedicated device on which the delégo supervision system is installed. The product is designed for installation on DIN profile rail and occupies 2 modules. The 12-24 Vdc power supply is external (power supply not included). The product with hardware based on embedded operating system, has a KNX TP node (twisted pair) and can therefore be connected directly to the bus network of KNX devices. It is also equipped with an RS485 port for connecting Modbus RTU slave type devices and an external USB port. The external connectivity is realized through the Ethernet port that connects the device directly to the home router. The integrated web server built with HTML5 technology allows access to the configuration environment and multi-user access to the display environment for fixed locations such as PC and MAC. The visualization environment, accessible with a standard browser, is organized in 3 levels with access to the area or floor, room and function. The functions can be managed in a logical way through graphic components or through graphic and synoptic maps. The system supports notifications for the user in case of events foreseen in the configuration phase.

The configuration environment includes a complete set of functions for the implementation of connected automation systems to KNX standards:

- Automatic import of the ETS project and merging with previous imports
- Configuration of the building structure in areas and rooms
- Association to the environments of the graphic components for the lighting (on/off, dimmed, RGB), climate (temperature, relative humidity and air quality control) and motorizations (shutters and blinds).
- Definition of scenarios, sequences of custom commands with timings (also configurable by the user in the visualization environment and on the mobile app)
- Time schedules on the elements of all defined graphical components (also configurable by the user in the visualization environment and on the mobile app)
- Graphic development environment with functional blocks to realize advanced logic (with library of combiners, gates, comparison and mathematical operators, counters, timers and triggers, astronomical clock)

The configuration environment provides management functions such as:

- Activation of ekinex cloud connection for automatic firmware update
- Voice-bridging service and selective activation of voice commands, extended to all defined graphic components, using Amazon and Google smart-speakers.

The local connection to the supervision for mobile devices with the app delégo is made via the WiFi access point integrated in the home router. Remote access can be achieved by direct exposure of the web-server to the Internet (via port forwarding) or via ekinex cloud access.

Versions, licenses and vouchers

- EK-DEL-SRV-BAS-TP: server delégo version with BASIC license. Maximum number of manageable KNX group addresses: 400. Unlimited number of rooms; scenarios: 100; programs with logic functions: 100. Acquisition of max 30 Modbus registers on RS485/TCP-IP from slave devices
- EK-DEL-SRV-ADV-TP: server delégo version with ADVANCED license. Maximum number of manageable KNX group addresses: 1200. Unlimited number of rooms; scenarios: 100; programs with logic functions: 100. Acquisition of max 30 Modbus registers on RS485/TCP-IP from slave devices
- EK-DEL-SRV-PRM-TP: server delégo version with PREMIUM license. Maximum number of manageable KNX group addresses: 2500. Unlimited number of rooms; scenarios: 100; programs with logic functions: 100. Acquisition of up to 30 Modbus registers on RS485/TCP-IP from slave devices.



Note. In case the supervision to be carried out requires a higher number of KNX group addresses than the one supported by the purchased product, the following upgrade software licenses are available (which can be activated with the appropriate code in the server device configuration environment):

EK-DEL-UPGR-BA upgrade license from BASIC to ADVANCED
EK-DEL-UPGR-BP upgrade license from BASIC to PREMIUM
EK-DEL-UPGR-AP upgrade license from ADVANCED to PREMIUM



Note. The integration in the supervision of Modbus RS485/TCP-IP slave devices (with number of registers > 30), the complete energy module and multimedia systems, video surveillance and intrusion detection requires the activation of vouchers through a special code in the configuration environment of the server device. For an updated list of available vouchers, please visit www.delego-ekinex.com in the appropriate section.

Main features

- 12-24 Vdc power supply (absorption 240 mA at 12 Vdc) by means of a special plug-in terminal supplied. Power supply not included
- KNX TP bus (twisted pair) via red-black terminal provided
- 1 Ethernet port via cat. 5 or higher cable and standard RJ45 connector
- 1 RS485 port for integration of Modbus RTU slave devices
- 1 USB 2.0 port: for future integrations
- 2 frontal LEDs: POWER LED for signalling the presence of power supply; SERVICE LED for signalling particular operations in progress.
- 1 RESET button housed under the front cover on the back of the vertical card

Technical Data:

Other features:

- Plastic housing
- Design for mounting on 35 mm profile rail (according to EN 60715)
- Degree of protection IP20 with product installed (according to EN 60529)
- Insulation class II (according to EN 60335-1)
- Climatic classification 3K5 (indoor, dry) and mechanical 3M2 (according to EN50491-2)
- Device weight: 120 g
- 2 UM modular device (1 UM = 18 mm)
- Dimensions 36 x 90.5 x 62 mm (W x H x D)

Environmental conditions

- Operating temperature: 0°C ... + 40°C
- Storage temperature: - 10 ... + 70°C
- Transport temperature: - 10 ... + 70°C
- Relative humidity: 95% non-condensing

Operating, signaling and connection elements

delégo server is equipped with status LEDs, a RESET button located under the front panel of the device, terminals for power supply connection, KNX bus line, Ethernet network, RS485 bus line and a USB port.

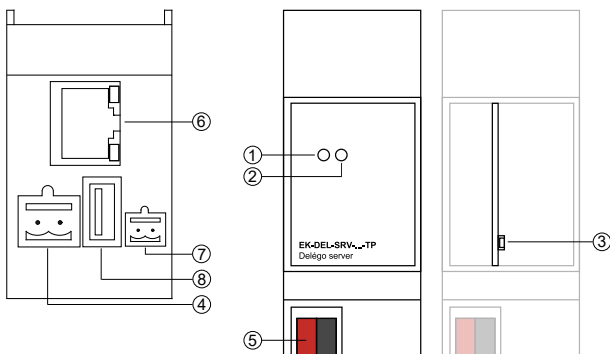

1. LED SERVICE
2. LED POWER
3. RESET push-button
4. Clamp for power-supply 12-24 Vdc
5. Clamp for KNX bus
6. RJ45 Ethernet plug
7. Clamp for RS485 network
8. 2.0 USB port

Signaling elements:

- POWER LED: indicates the presence of 12-24 Vdc power supply at terminals
- SERVICE LED: Normally off, steady mode or flashing during IP address recovery sequences or factory re-configurations

Control elements:

- RESET button: must be pressed to activate IP address reset sequences or factory settings.



Note. The RESET button is not directly accessible on the front panel of the product. To access the button, open the front panel of the delégo server using a small slotted screwdriver and exerting a slight leverage effect in one of the side slots. Locate the RESET button on the back of the vertical board at the bottom of the device towards the KNX terminals.

Mounting

The device has degree of protection IP20, and is therefore suitable for use in dry interior rooms. The housing is made for rail mounting according to EN 60715 in boards or cabinets for electrical distribution. The installation is in horizontal position, the correct position is when the KNX bus terminal is located at the bottom and the terminals for the outputs are located at the top. For the installation of the device on the rail proceed as follows:

- with the aid of a tool bring the locking device in the fully lowered position (1);
- place the upper edge of the rear inner profile on the upper edge of the rail (2);
- rotate the device towards the rail (3);
- push the locking device upward until it stops (4).

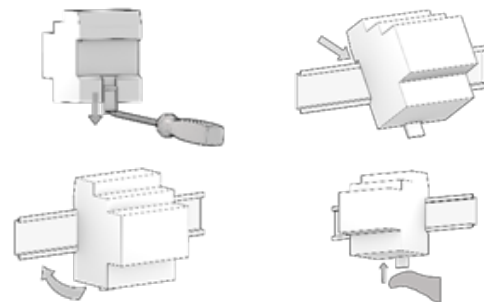

Before removing the device, be sure the inputs have been disconnected and the bus terminal has been extracted from its slot. Use a screwdriver to slide down the locking device and remove the device from the rail.



Note. It is recommended that the installation of the device always ensure the full accessibility of the front side to allow the led visualization.

Power 12-24 Vdc

The connection to the power supply is made via the screw terminals (1)+ and (2)- located on the removable 2-pin connector.

Clamp characteristics

- Screw tightening of conductors
- Max. conductor cross-section 2.5 mm²
- Recommended conductor stripping approx. 6 mm
- Max. torque 0.5 Nm

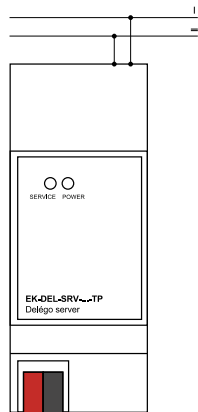

Warning! The electrical connection of the device may only be carried out by qualified personnel.

Connection to the KNX bus network

The connection to the bus network is made via the KNX terminal included in the scope of delivery and inserted into the housing on the front of the device at the bottom.

KNX clamp characteristics

- Spring clamping of the conductors
- 4 conductor seats for each polarity
- Suitable for KNX bus cable with single conductors between 0.6 and 0.8 mm diameter
- Recommended conductor stripping approx. 5 mm
- Colour coding: red = bus conductor + (positive), black = bus conductor - (negative)



Warning! Only use KNX bus power supplies (e.g. ekinex EK-AB1-TP or EK-AG1-TP) to supply the KNX bus lines. The use of other power supply devices can impair communication and damage the devices connected to the bus.

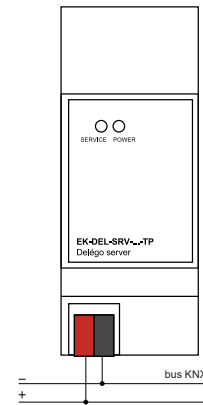

Connection to RS485 bus

The connection to the RS485 bus network is made via the screw terminals (1) RT+ and (2) RT- located on the removable 2-pin connector.

Clamp characteristics

- Screw tightening of conductors
- Max. conductor cross-section 2.5 mm²
- Recommended conductor stripping approx. 6 mm
- Max. torque 0.5 Nm

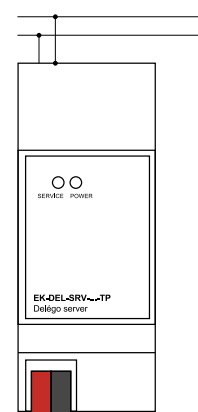

Configuration and commissioning

The configuration and commissioning of the delégo server must be carried out by accessing the web server integrated in the product. These activities must be carried out in accordance with the design of the building automation system carried out by a qualified professional.

Network connection

The configuration and use of the delégo server requires a connection to the home or company network. The default IP address of the delégo server is: **192.168.0.110**. For the initial configuration of the server, as well as in case of absence of a network during the installation phase, it is necessary to proceed as follows:

1. connect the server delégo to your PC via a "cross over" (or "crossover") network cable
2. access your PC's network settings, as illustrated in your operating system documentation
3. Change the TCP/IP communication protocol settings (version 4) for the LAN port of your PC, and set the following parameters manually:

- IP address: 192.168.0.100
- Network mask: 255.255.255.0
- Default gateway: 192.168.0.110
- Save and wait for the new settings to take effect. If prompted, reboot the system.

After these operations, open an Internet browser and type in the address bar:

<http://192.168.0.110>



Note! For an optimal browsing experience, we recommend using one of the following browsers:

- **Google Chrome**
- **Apple Safari**

First access

When you open the browser at the default address, the following login screen is displayed:

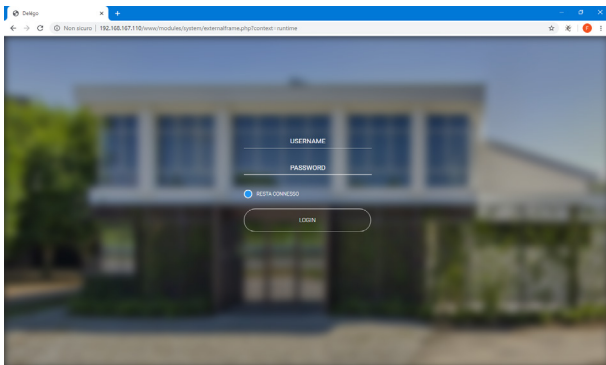

delégo server has the following preset users at the factory:

User	Password	Description
admin	admin	Automation system administrator user. He has the rights to create users, manage their rights and configure the supervision.
user	user	Basic user. It has the rights to view the system status, navigate the supervision pages and perform basic commands on the automation system.

Enter the credentials of the user “admin” and confirm to access the main screen of the delégo administration environment.

Restore factory IP address

If necessary, you can restore the factory IP address of the server delégo using the RESET button available. Follow the procedure below:

- open the front panel of the server delégo using a small slotted screwdriver, and exerting a slight leverage effect in one of the side slots
- locate the RESET button on the back of the vertical card
- Press the button for at least 10 seconds until the SERVICE LED on the front of the device starts flashing, then release the button.
- within the next 5 seconds, press and release the button for 1 second; within a couple of seconds the front LED will light up solidly for a couple of seconds
- When the LED goes out, the device can be reached at the factory IP address (192.168.0.110).

If the LED goes out after long press (10 seconds) before short press, repeat the whole procedure. This procedure resets the IP address and retains all data relating to the configuration previously carried out on the automation system.

Restore factory configuration

If the configuration made makes it impossible to access the server delégo or its correct use, it is possible to restore the factory conditions, resetting the IP address and emptying the supervision project using the “RESET” button available. In this case, compared to what was previously seen to restore the IP address, the procedure to follow is the following:

- open the front panel of the server delégo using a small slotted screwdriver, and exerting a slight leverage effect in one of the side slots
- locate the RESET button on the back of the vertical card
- Press the RESET button for at least 10 seconds until the SERVICE LED on the front of the device starts flashing, then release the button.
- within the next 5 seconds, press and hold the button for at least 10 seconds
- When the LED is solidly lit, release the button and wait for it to go out.
- when the LED goes off, remove and restore the power supply
- Wait about one minute and log in to the server with the factory IP address (192.168.0.110).



Warning! To avoid losing all the configurations made for the automation project during a factory reset operation, it is recommended to make periodic backups of the supervision project.



The configuration and commissioning activities of the delégo server device require specialized skills on the KNX network and knowledge of the specific automation project carried out with ETS. To acquire these skills, it is essential to participate in the courses organized at KNX certified training centers. For further information: www.knx.it

Dimensions [mm]

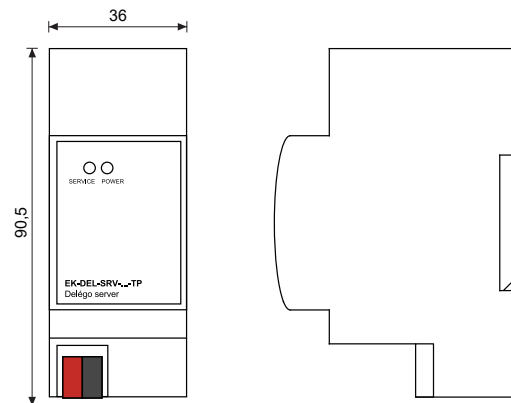

Approvals

- CE The products comply with the Low Voltage Directive (2014/35 / EU) and the Electromagnetic Compatibility Directive (2014/30 / EU). Tests carried out in accordance with EN 50491-5-1: 2010, EN 50491-5-2: 2010.

Maintenance

The devices are maintenance-free. To clean them, use a dry cloth. The use of solvents or other aggressive substances is absolutely to be avoided.

Disposal



The products described in this technical sheet at the end of its useful life are classified as waste from electronic equipment according to the European Directive 2012/19 / EU (RAEE recast), implemented in Italy with Legislative Decree no. 49 of 14 March 2014, and cannot be transferred to unsorted municipal solid waste.



Important! Incorrect disposal of the product can cause serious damage to the environment and human health. For correct disposal, inquire about the collection and treatment methods provided by the local authorities.

Document

This technical sheet refers to the A1.0 release of ekinex® devices cod. EK-DEL-SRV-BAS-TP, EK-DEL-SRV-ADV-TP ed EK-DEL-SRV-PRM-TP and is available for download on the website www.ekinex.com in PDF (Portable Data Format).

File Name	Device Release	Update
STEKDELSRVXXXTP_EN.pdf	A1.0	06 / 2020

Warnings

- Installation, electrical connection, configuration and commissioning of the device may only be carried out by qualified personnel in accordance with the applicable technical regulations and the laws in force in the respective countries.
- The device may not be used in safety applications. However, the device may be used for auxiliary signalling functions.
- Opening the housing of the device results in the immediate interruption of the warranty period.
- In the event of tampering, compliance with the essential requirements of the applicable directives for which the device has been certified is no longer guaranteed.
- Defective ekinex® KNX devices must be returned to the manufacturer at the following address: Ekinex S.p.A., Via Novara 37 - I-28010 Vaprio d'Agogna NO

Other useful informations

- This technical data sheet is addressed to installers, system integrators and designers
- For more information on the product, you can contact ekinex® technical support at the e-mail address: support@ekinex.com or consult the website www.ekinex.com
- Each ekinex® device has a unique serial number on the label. The serial number can be used by installers and system integrators for documentation purposes and must be added to any communication addressed to ekinex® technical support in case of equipment malfunction.
- ekinex® is a registered trademark of Ekinex S.p.A.
- KNX® and ETS® are registered trademarks of KNX Association cvba, Brussels.

© Ekinex S.p.A. 2020. The company reserves the right to make changes to this technical documentation without notice.