

Pushbutton 71 Serie

Code: EK-E12-TP-...



Datasheet STEKE12TP_EN

KNX device for switching and control of single loads or groups of loads and room temperature regulation. It has to be used in KNX installations for control of homes and buildings.

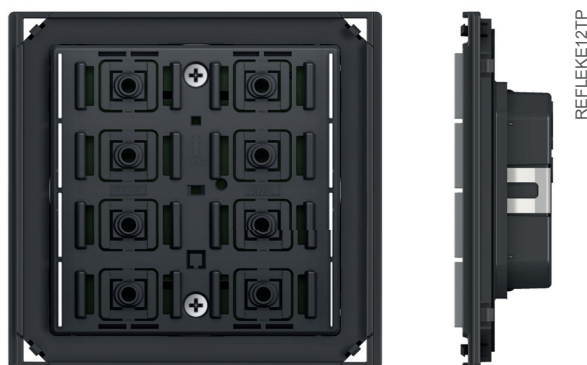

Description

The ekinex® pushbutton of 71 Serie is a KNX S-mode device for on/off switching of loads, dimming of lighting devices, controlling of motor drives or other programmable switching and control functions. The integrated temperature sensor allows the use as a room or zone temperature controller. It is equipped with an integrated KNX bus communication module and is designed for wall installation on flush-mounting box. Each channel can be freely configured to carry out 1 or 2 bus functions and is provided with programmable LED (blue/green or red/white) e.g. as a status feedback or orientation nightlight. Pressing a rocker, the device sends on the bus a telegram, which is received and executed by one or more KNX actuators depending on the configuration carried out. The device is powered by the KNX bus line with a SELV voltage 30 Vdc and does not require auxiliary power.

Versions

Device code	LED colours	Mounting
EK-E12-TP	blue / green	with frame of the form or flank series
EK-E12-TP-RW	red / white	
EK-E12-TP-BG-NF	blue / green	without frame ('NF series')
EK-E12-TP-RW-NF	red / white	
EK-E12-TP-BG-NFW	blue / green	without frame ('NF series') with white adapter
EK-E12-TP-RW-NFW	red / white	



Note. The set of rockers, the plate and the optional frame for completing the device must be ordered separately. For more information, see also the ekinex® product catalog or browse www.ekinex.com

Main functional characteristics

- On/off switching of single loads or groups of loads
- Dimming of lighting devices
- Control of motor drives (for roller shutters, blinds, curtains, etc.)
- Room temperature regulation
- Logic functions
- Sending on the bus of values (temperature, brightness, etc.)
- Switching to forced functioning (lock)
- Recalling and saving of scenes
- Measuring of room temperature and light brightness through integrated sensors
- Different functions programmable for short pressure / long pressure of a rocker
- Status feedback or orientation nightlight through 2-colour programmable LEDs

Other characteristics

- Housing in plastic material
- Wall installation in flush mounting box
- Protection degree IP20 (according to EN 60529)
- Classification climatic 3K5 and mechanical 3M2 (according to EN 50491-2)
- Pollution degree 2 (according to IEC 60664-1)
- Weight 40 g (70 g with mounting support)
- Dimensions 81 x 77 x 21 mm (WxHxD)

Technical data

- Power supply 30 Vdc from KNX bus line
- Current consumption < 15 mA
- Power from bus < 360 mW

Environmental conditions

- Operating temperature: - 5 ... + 45°C
- Storage temperature: - 25 ... + 55°C
- Transport temperature: - 25 ... + 70°C
- Relative humidity: 95% not condensing

Delivery

The delivery of the pushbutton includes a metallic support for round flush-mounting box, the fixing screws (2 pairs) and the KNX terminal block for connection of the bus line.



Device completed with square plate, 1-fold Form frame and set of rockers EK-T1Q-...



Device completed with square plate, 1-fold Form frame and set of rockers EK-T2R-...



Device completed with square plate, 1-fold Form frame and set of rockers EK-T4Q-...



Device completed with square plate, 1-fold Form frame and set of rockers EK-T4R-...





Completion of the pushbutton

The pushbutton is completed through a separate order of:

- a set of rockers that allows the use as a 1-fold, 2-fold or 4-fold pushbutton;
- a 1-fold plate (square, EK-PQS-...) or a 2-fold plate (rectangular, EK-P2G-... or EK-P2S-...) in combination with another bus device of 71 Serie or a 55 x 55 mm flush-mounting insert;
- a square frame of the ekinex® form or flank series (not for the 'NF - No Frame versions).

Rockers



Three-positions rockers with central neutral position have to be mounted on the pushbutton. Pushing one side of a rocker (for example the upper one), the pushbutton sends on the bus a telegram for switching on, increasing the brightness of luminaires or raising the blinds, while pushing the other side (for example the lower one), it sends a telegram for switching off, reducing the brightness of luminaires or lowering the blinds. Each channel is equipped with LEDs which can be freely programmed as status feedbacks of the loads and as orientation nightlight.

Code set of rockers *	Appearance	Nr. and type of rockers	Modularity [mm]
EK-T1Q-xxx		1 square	60 x 60
EK-T2R-xxx		2 rectangular	30 x 60
EK-T4Q-xxx		4 square	30 x 30
EK-T4R-xxx		4 rectangular	60 x 15

(*) To be completed with the extension for the colour: xxx = MAA (white), xxx = GAG (silver), xxx = MAL (black)

Plate

The pushbutton may be completed by a square 1-fold plate or by a rectangular 2-fold plate. In both cases the plate must be necessarily provided with a 60 x 60 mm window for the mounting of the device.

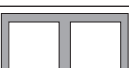
Plate code *	Type	Appearance	Window modularity [mm]
EK-PQS-...	1-fold **		60 x 60
EK-P2G-...	2-fold ***		55 x 55 (1) 60 x 60 (1)
EK-P2S-...	2-fold ***		60 x 60 (2)

(*) To be completed with the extension for colour, material and finishing

(**) For mounting without frame (NF) it requires the EK-TAQ adapter

(***) For mounting without frame (NF) it requires the EK-A71-... adapter

Frame

The pushbutton can be completed by a square 1-fold frame or by a rectangular 2-fold frame of the flank or form series. The 'NF (No Frame) versions of the pushbutton do not require any frame.

Mounting

The device has degree of protection IP20, and is therefore suitable for use in dry interior rooms. The installation of the device differs depending on the mounting with or without frame ('NF series).

Mounting with frame

Carry out the following steps:

- fix the metallic support (h) with the pair of screws (g) on the flush-mounting box (i) equipped with fixing holes at 60 mm distance;
- press for fixing the pushbutton (d) on the adapter (e);
- insert pushbutton and adapter (d+e) in the metallic support (h). Mounting the device follow also the indication TOP (arrow tip pointing up) on the rear side of the device;
- snap a square frame (f) of the form or flank series, inserting it from the rear of the pushbutton (d);
- enter the bus terminal block, previously connected to the bus cable in its slot on the rear side (see also: "Connection of the KNX bus line"). At this point it is recommended to carry out the commissioning of the device (see also "Configuration and commissioning") or at least the download of the physical address;
- fasten the device on the metallic support supplied with the pair of screws (c);
- snap the rockers (b) for the operation of the device;
- snap the plate (a).

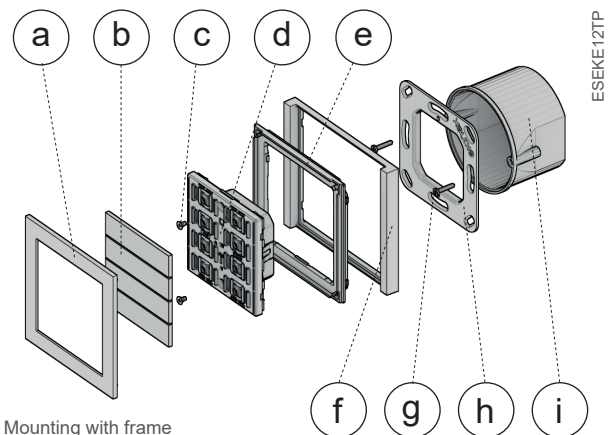

Mounting with frame

- a) 1-fold plate
- b) Rockers
- c) Fixing screws (for device)
- d) Device (pushbutton 71 Serie)
- e) Adapter for mounting with frame (included in the delivery)
- f) Frame (square, form or flank series)
- g) Fixing screws (for metallic support)
- h) Metallic mounting support
- i) Flush-mounting box

Mounting without frame ('NF series)

Carry out the following steps:

- insert the metallic support (f) on the adapter (g);
- fix adapter and support (f+g) with the pair of screws (e) on the flush-mounting box (h) equipped with fixing holes at 60 mm distance;
- enter the bus terminal block, previously connected to the bus cable in its slot on the rear side (see also: "Connection of the KNX bus line"). At this point it is recommended to carry out the commissioning of the device (see also "Configuration and commissioning") or at least the download of the physical address;
- insert the pushbutton (d) on the metallic support (f);
- fasten the device on the metallic support supplied with the pair of screws (c);
- snap the rockers (b) for the operation of the device;
- snap the plate (a).

The pushbutton has to be mounted on a round or square flush-mounting box with distance between fixing holes of 60 mm. If necessary, the metallic support for mounting on the wall box can also be ordered separately using the code EK-S71.

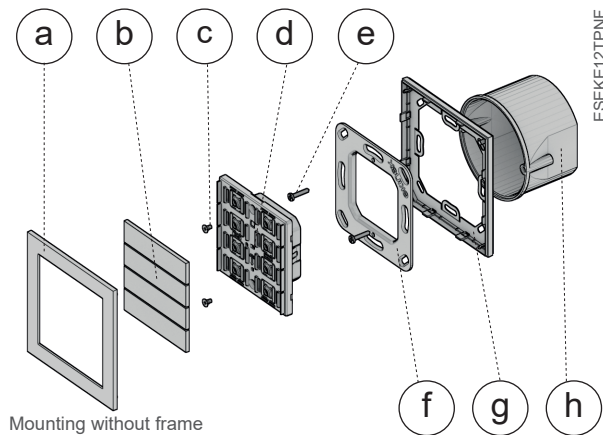

Mounting without frame

- a) 1-fold plate
- b) Rockers
- c) Fixing screws (for device)
- d) Device (pushbutton 71 Serie, 'NF version')
- e) Fixing screws (for metallic support)
- f) Metallic mounting support
- g) Adapter for 'NF series (included in the delivery)
- h) Flush-mounting box



Note. Programming pushbutton and LED are accessible from the front side of the device. It is better addressing the device before the final assembly of rockers and frame. Once the addressing has been performed, the device configuration can be later downloaded without pressing the programming pushbutton.

Mounting position

If the integrated sensor is used for temperature regulation, the device has to be installed preferably on an internal wall at the height of 1,5 m and at least 0,3 m far from doors. The device can not be installed close to heat sources such as radiators or household appliances or in position subjected to direct sunlight. If necessary, for the regulation can be used a weighted average value between the value measured by the integrated sensor and a value received via bus by another KNX device.

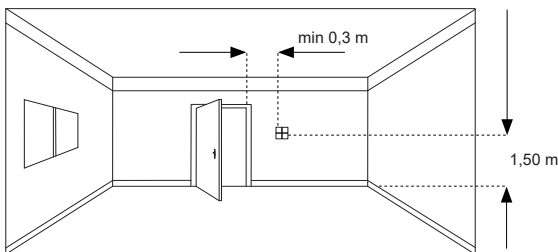

Use as a room temperature controller

The pushbutton can be also used as a room temperature controller for single-stage heating/cooling systems with radiators, radiant panels and electrical heaters. As the device has no user interface, it must receive the operational parameters by the bus (e.g. operating mode, seasonal conduction mode or a change of the setpoint value).

Main functional characteristics (room temperature controller)

- Temperature measuring through integrated sensor with possibility of sending the value on the bus
- 2-point (on/off) or proportional (PWM or continuous) room temperature regulation
- Seasonal conduction modes: heating and cooling with possibility of changeover via bus or automatic depending on the configuration
- Operating modes: comfort, standby, economy and building protection with different setpoint for heating and cooling
- Automatic switching of the operating modes triggered by window opening/closing
- Weighted average of two temperature values
- Temperature control alarm
- Anti-locking function for valves (hydraulic systems)

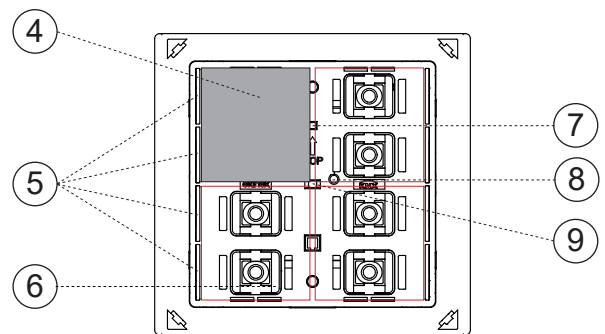
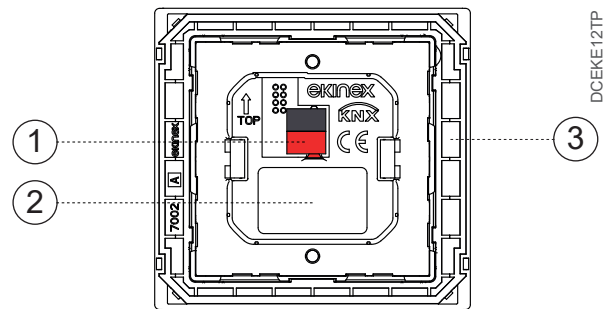

- 1) Connection terminal block for KNX bus line
- 2) Product label
- 3) Adapter
- 4) Rocker (in the example: 30 x 30 mm square type)
- 5) LED-lightguide
- 6) Positioning of the temperature sensor
- 7) Programming LED
- 8) Programming pushbutton
- 9) Brightness sensor

Switching, display and connection elements

The device is equipped with four mechanisms for switching, four LEDs for each channel, a programming LED and a programming pushbutton and a terminal block for connection of the bus line.

Switching elements

- Pushbutton (8) for switching between the normal and programming operating modes
- One, two or four rockers (4) for independent switching of single or group of loads

Display elements

- Red LED (7) for indication of the active operating mode (on = programming, off = normal operation)
- Freely programmable LED with lightguide (5) e.g. for feedback status and orientation nightlight LED

Connection of the KNX bus line

The connection of the KNX bus line is made with the terminal block (black/red) included in delivery and inserted into the slot of the housing.

Characteristics of the KNX terminal block

- spring clamping of conductors
- 4 seats for conductors for each polarity
- terminal suitable for KNX bus cable with single-wire conductors and diameter between 0.6 and 0.8 mm
- recommended wire stripping approx. 5 mm
- color codification: red = + (positive) bus conductor, black = - (negative) bus conductor



Warning! In order to supply the KNX bus lines use only KNX bus power supplies (e.g. ekinex EK-AB1-TP or EK-AG1-TP). The use of other power supplies can compromise the communication and damage the devices connected to the bus.

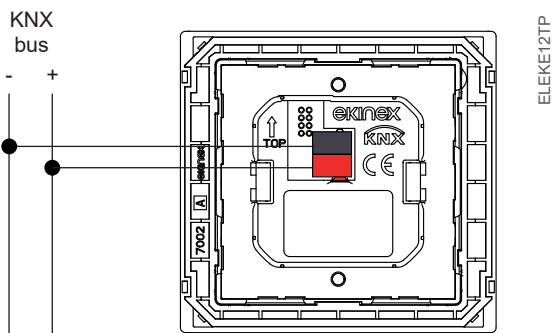

Warning! The electrical connection of the device can be carried out only by qualified personnel. The incorrect installation may result in electric shock or fire. Before making the electrical connections, make sure the power supply has been turned off.

Configuration and commissioning

Configuration and commissioning of the device require the use of the ETS® (Engineering Tool Software) program V4 or later releases. These activities must be carried out according to the design of the building automation system done by a qualified planner.



Note. The configuration and commissioning of KNX devices require specialized skills. To acquire these skills, you should attend the workshops at KNX certified training centers.

Configuration

For the configuration of the device parameters the corresponding application program or the whole ekinex® product database must be loaded in the ETS program. For detailed information on configuration options, refer to the application manual of the device available on the website www.ekinex.com.

Product code	Application program (## = release)	Communication objects (nr. max)	Group addresses (nr. max)
EK-E12-TP	APEKE12TP##.knxprod	222	222

Commissioning

For commissioning the device the following activities are required:

- make the electrical connections as described above;
- turn on the bus power supply;
- switch the device operation to the programming mode by pressing the programming pushbutton located on the front side of the housing. In this mode of operation, the programming LED is turned on;
- download into the device the physical address and the configuration with the ETS® program.

At the end of the download the operation of the device automatically returns to normal mode; in this mode the programming LED is turned off. Now the bus device is programmed and ready for use.

Dimensions [mm]

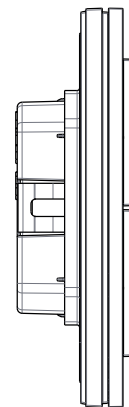
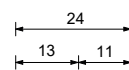
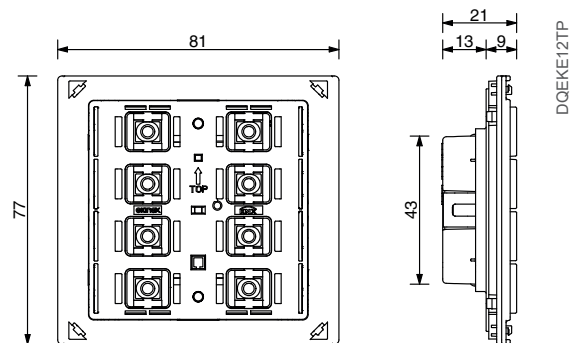

71 Serie pushbutton for mounting without frame ('NF series), completed with rockers and plate EK-PQS-...

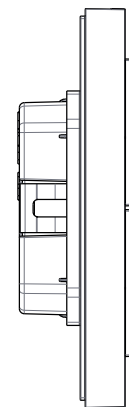
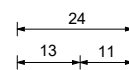

71 Serie pushbutton for mounting with frame of Form or Flank series, completed with rockers and plate EK-PQS-...

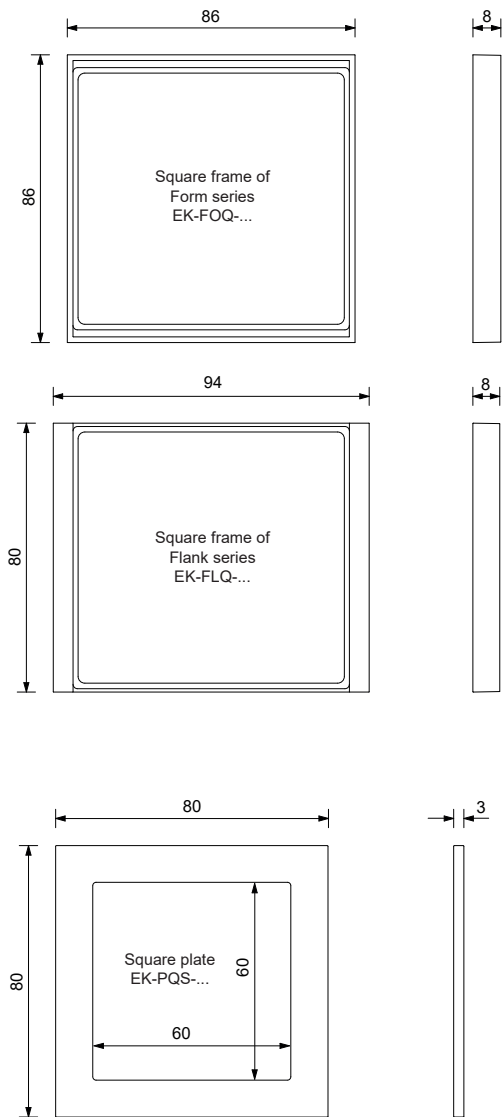

Marks

- KNX
- CE: the device complies with the Low Voltage Directive (2006/95/EC) and the Electromagnetic Compatibility Directive (2004/108/EC). Tests carried out according to EN 50491-5-1:2010, EN 50491-5-2:2010

Maintenance

The device is maintenance-free. To clean use a dry cloth. It must be avoided the use of solvents or other aggressive substances.

Disposal



At the end of its useful life the product described in this datasheet is classified as waste from electronic equipment in accordance with the European Directive 2002/96/EC (WEEE), and cannot be disposed together with the municipal undifferentiated solid waste.



Warning! Incorrect disposal of this product may cause serious damage to the environment and human health. Please be informed about the correct disposal procedures for waste collecting and processing provided by local authorities.

Documentation

This datasheet refers to the release A1.0 of the ekinex® device EK-E12-TP..., and is available for download at www.ekinex.com as a PDF (Portable Data Format) file.

File name	Device release	Updating
STEKE12TP_EN.pdf	A1.0	11 / 2015

Documentation

This datasheet refers to the release A1.0 of the ekinex® device EK-E12-TP..., and is available for download at www.ekinex.com as a PDF (Portable Data Format) file.

Warnings

- Installation, electrical connection, configuration and commissioning of the device can only be carried out by qualified personnel in compliance with the applicable technical standards and laws of the respective countries
- Opening the housing of the device causes the immediate end of the warranty period
- In case of tampering, the compliance with the essential requirements of the applicable directives, for which the device has been certified, is no longer guaranteed
- ekinex® KNX defective devices must be returned to the manufacturer at the following address: EKINEX S.p.A. Via Novara 37, I-28010 Vaprio d'Agogna (NO) Italy

Other information

- This datasheet is aimed at installers, system integrators and planners
- For further information on the product, please contact the ekinex® technical support at the e-mail address: support@ekinex.com or visit the website www.ekinex.com
- Each ekinex® device has a unique serial number on the label. The serial number can be used by installers or system integrators for documentation purposes and has to be added in each communication addressed to the EKINEX technical support in case of malfunctioning of the device
- KNX® and ETS® are registered trademarks of KNX Association cvba, Brussels

© EKINEX S.p.A. The company reserves the right to make changes to this documentation without notice.